

Electrical Circuits:

Many real world electronic devices are just collections of wires, resistors, capacitors, and batteries, forming circuits that do something (flashlights, toasters, blowdryers, radios, amplifiers,...) It's important to understand (and predict) the currents and voltages in such circuits. E.g., consider first a simple “flashlight circuit”:

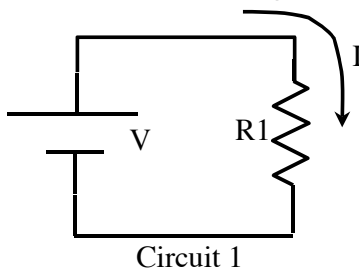

The “R” here might represent the resistance of the flashlight bulb.

Here, $V=I \cdot R_1$, or $I = V \cdot (1/R_1)$

Now consider a slightly more complicated circuit:

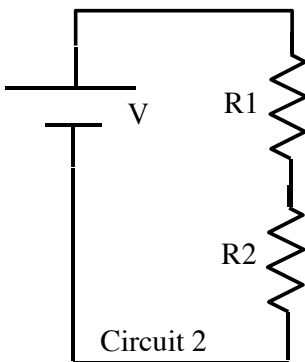

These resistors are in *series*.

There will be a voltage drop $V_1 = I \cdot R_1$ across the first resistor, and $V_2 = I \cdot R_2$ across the second.

The TOTAL voltage drop from top to bottom is $V = V_1 + V_2 = I \cdot (R_1 + R_2)$

The resistances simply add up!

In other words, this circuit is essentially *equivalent* to the following simpler circuit:

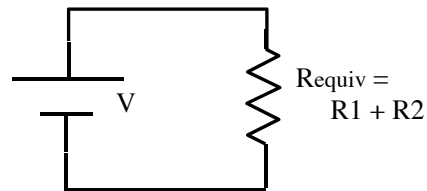

Similarly, for many resistors in series: $R_{equiv} = R_1 + R_2 + R_3 + \dots$

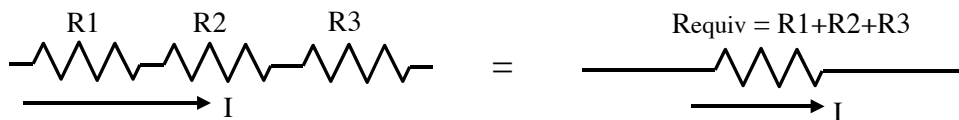

Important: the current I is the SAME through each of these series resistors. (What goes in must come out: conservation of charge! This is not an approximation of any kind, it's exactly true)

However, that doesn't mean the current I in circuit 1 is the same as the current in circuit 2. Those are *different* circuits....

Here's a different circuit. We say R_1 and R_2 are "in parallel":

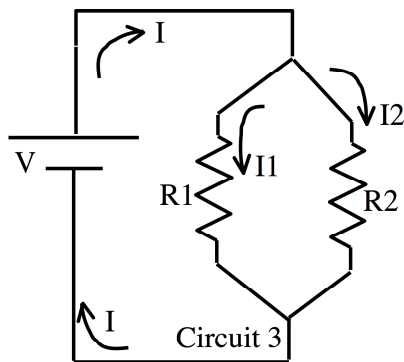

This time, the current I is NOT necessarily the same through R_1 and R_2 .

The current divides up: I_1 goes left, I_2 goes right.

(Conservation of charge, however, does tell us that $I = I_1 + I_2$, can you see why that is? Charges can't be created

or destroyed here - they must go SOMEWHERE, and current just "counts the charges that flow by/sec")

It *also* says I at the bottom (going into the battery) is exactly the same as I at the top (leaving the battery)

Note: *the voltage across R_1 is exactly the same as the voltage across R_2 !* This is an important point, stare at the picture and try to understand why. Think of this as two different ski runs. Both have the same top and bottom (the same *height*, the same *voltage*), but they have different resistances, so different number of skiers/hour. (Different *currents* through each resistor)

Or, you might think of water flowing through pipes:
Here, the difference in pressure (like voltage difference) is exactly the same for both pipes (pressure at the top of either is identical, pressure at the bottom of either is identical, so the difference across either is identical) but the current through each will be different.

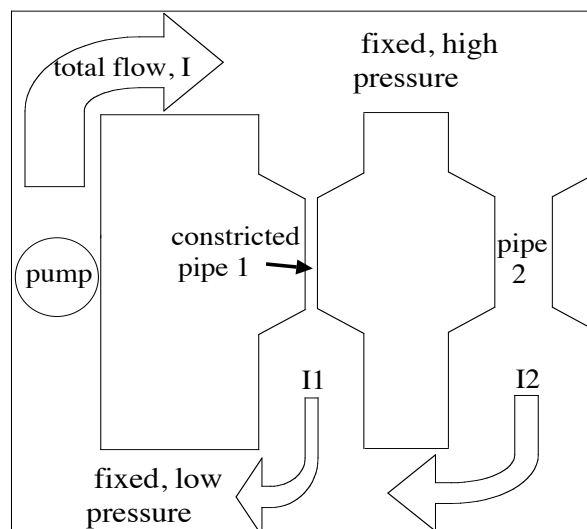

The total current is just the sum of the two currents, $I = I_1 + I_2$

The previous parallel circuit (#3) is essentially *equivalent* to the following simpler circuit:

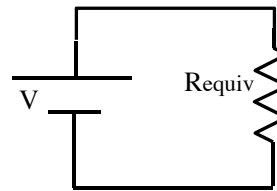

In this situation (resistors “in parallel”) I claim

$$\frac{1}{R_{\text{equivalent}}} = \frac{1}{R_1} + \frac{1}{R_2} + \frac{1}{R_3} + \dots$$

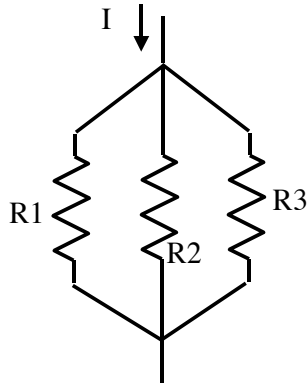

We can prove it mathematically (if you’re interested):

It comes from the fact that $I = V / R_{\text{equiv}}$,

but conservation of charge says

$$I = I_1 + I_2 + I_3 + \dots = \frac{V}{R_1} + \frac{V}{R_2} + \frac{V}{R_3} + \dots$$

$$= V * \left(\frac{1}{R_1} + \frac{1}{R_2} + \frac{1}{R_3} + \dots \right) = V / R_{\text{equiv}}$$

Examples of equivalent resistances:

$$\frac{1}{R_{\text{equivalent}}} = \frac{1}{100 \Omega} + \frac{1}{100 \Omega} = .02 \Omega^{-1},$$

i.e. $R_{\text{equivalent}} = 1 / (.02 \Omega^{-1}) = 50 \Omega$

$$\frac{1}{R_{\text{equivalent}}} = \frac{1}{2 \Omega} + \frac{1}{1 \Omega} = 1.5 \Omega^{-1},$$

i.e. $R_{\text{equivalent}} = 1 / (1.5 \Omega^{-1}) = 0.67 \Omega$

$$\frac{1}{R_{\text{equivalent}}} = \frac{1}{2 \Omega} + \frac{1}{0 \Omega} = (0.5 + \infty) \Omega^{-1} = \infty \Omega^{-1},$$

i.e. $R_{\text{equivalent}} = 1 / (\infty \Omega^{-1}) = 0. \Omega$

0 Ω => (short circuit!)

(The last is a short circuit, 0 resistance. All the current is happy to flow through the 0 Ω side!)

Note that R_{Equiv} *always* comes out *less* than any of the individual parallel R's. That means, if there are two (or more) ways for the current to go, there is **LESS** overall resistance to flow.

(More ways for current to flow makes it *easier* for the current to flow. More ski runs at a resort means you can get *more* people skiing: more current, less *overall resistance*.)

You can have both parallel and series together. To find the “single equivalent resistor”, just “break it apart” bit by bit:

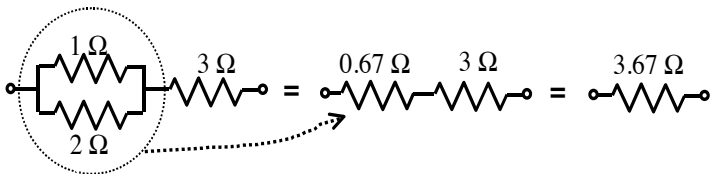

Drawing circuits requires some abstraction. The real situation may *look* different, but be equivalent. The fact that wires can have funny shapes makes things especially confusing. So, e.g. the following two circuits are exactly the same:

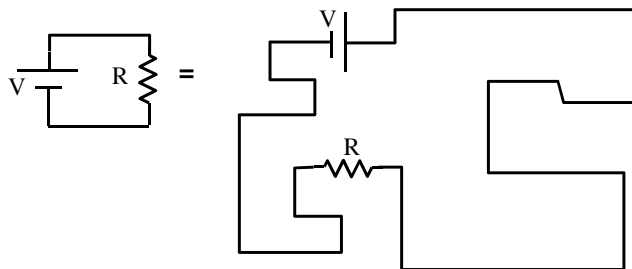

Straight lines (even with bends) always represent ideal wires. So you need to think hard in lots of these pictures!

E.g. here's another pair of circuits which are exactly the same. (I labeled some points, to help guide your eye). Study this and *convince yourself* that it's two different representations of the SAME CIRCUIT.

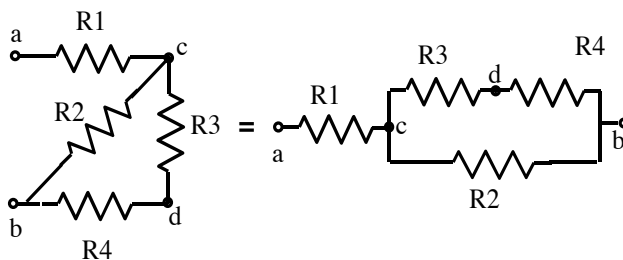

If I asked for the “equivalent resistance” between a and b in the above two, the one on the left looks scary.

But the one on the right makes it apparent that it's not so bad, just combine R_3 and R_4 (which are in series) to get this picture:

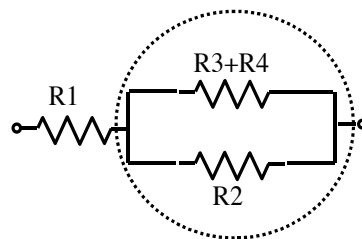

Now you could combine “ R_3+R_4 ” with “ R_2 ”, which are manifestly in parallel (dotted circle), and add R_1 to get the equivalent resistance. (It's not as hard as the 1st picture implied!)

Here's yet another example of identical circuits. ALL the pictures represent exactly the same situation! Again, study them all, and convince yourself that there's no difference!

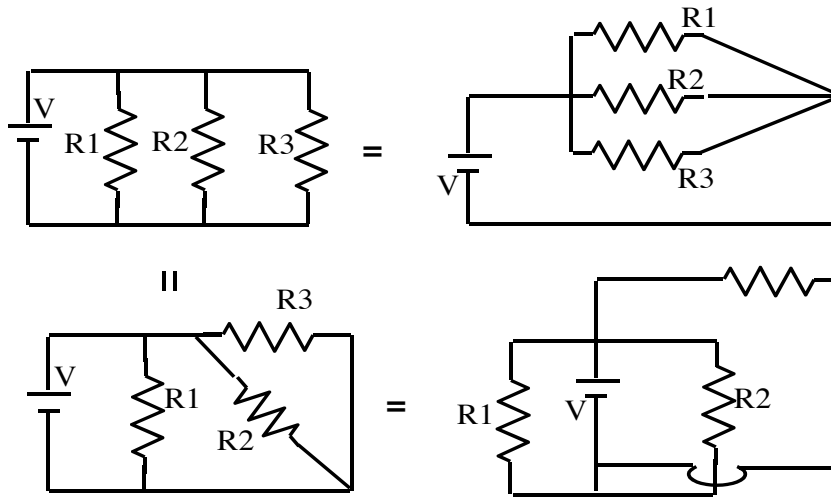

All those circuits are just 3 resistors in parallel. I personally prefer the first drawing, because it makes it visually obvious that the voltage V across all 3 resistors is exactly the same. (Like 3 parallel runs down the ski hill) By the way, this setup is pretty much how houses are wired up for appliances: here's one MORE drawing, which is pretty much equivalent to all the ones above:

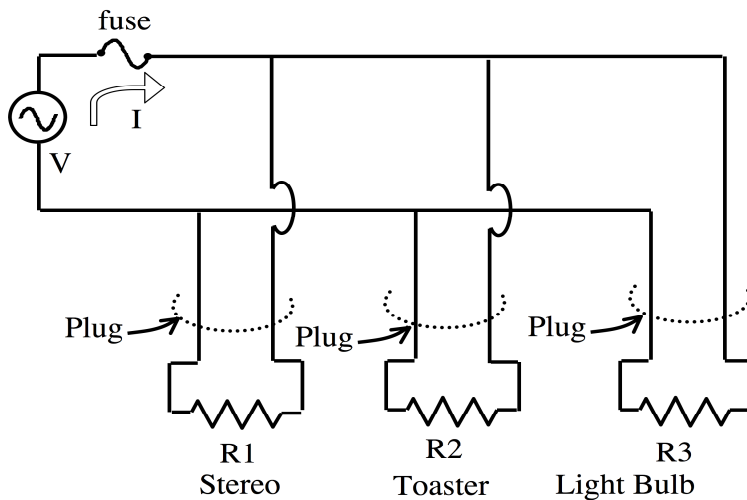

($V=120$ V AC, the fuse shuts off current to all 3 appliances if I exceeds about 15-20 A)

Another example. Here's a more complicated circuit, let's find the currents I_1 , I_2 , and I_3 . And, let's find V_{ab} , the voltage difference between points a and b.

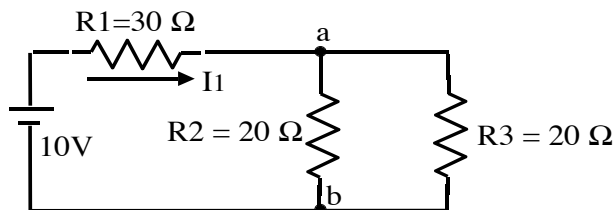

Look at R_2 and R_3 .
They're in parallel.

So we can combine them into an effective single resistor.

The circuit is equivalent to this one

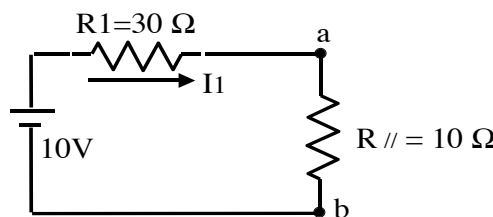

I know what $R_{//}$ is because

$$\frac{1}{R_{//}} = \frac{1}{R_2} + \frac{1}{R_3} = \frac{1}{20\Omega} + \frac{1}{20\Omega} = 0.1\Omega^{-1},$$

$$i.e. R_{//} = 10\Omega.$$

But now you can see we have two resistors in series. Thus, this circuit in turn is effectively equivalent to the next one:

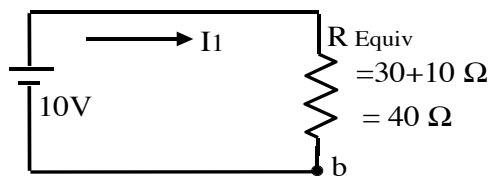

Life is easy at this point!

$$\text{Use } V = I_1 R_{\text{equiv}},$$

giving

$$I_1 = (10 \text{ V}) / (40 \text{ Ohm}) = 0.25 \text{ A}.$$

This tells us I_1 (the same in any of the diagrams!)

To find V_{ab} , go back a step to the "equivalent circuit" just above.

In that picture, you can see that

$$V_{ab} = I_1 * R_{//} = 0.25 \text{ A} * 10 \text{ Ohm} = 2.5 \text{ V}.$$

To find I_2 and I_3 , you go back yet another step, to the very top-most picture. (Note! V_{ab} is the *same* across resistors 2 and 3)

$$V_{ab} = I_2 R_2 \Rightarrow I_2 = V_{ab} / R_2 = 2.5 \text{ V} / 20 \Omega = 0.125 \text{ A}$$

$$V_{ab} = I_3 R_3 \Rightarrow I_3 = V_{ab} / R_3 = 2.5 \text{ V} / 20 \Omega = 0.125 \text{ A}$$

(Also notice: $I_2 + I_3 = .125 + .125 = .25 \text{ A} = I_1$, which makes sense!)

There are devices to measure V , I , and R in circuits.

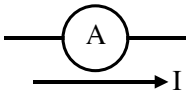

An *ammeter*: a device that measures the current running through itself.

(An ideal ammeter has *zero* internal resistance, so it won't hinder the current it is trying to measure...)

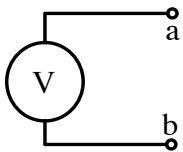

A *voltmeter*: a device that measures the voltage difference across its terminals:

$$V_{ab} = V_a - V_b.$$

(An ideal voltmeter has *infinite* internal resistance, so it won't alter the voltage it is trying to measure. It won't suck any current into itself...)

Examples of simple circuits with volt- and ammeters in place:

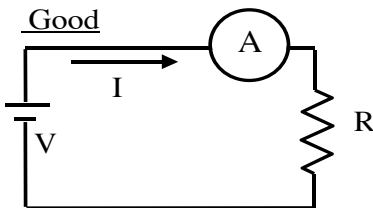

To measure the current " I " flowing through the resistor R in this circuit, we must place the ammeter in *series*, as shown.

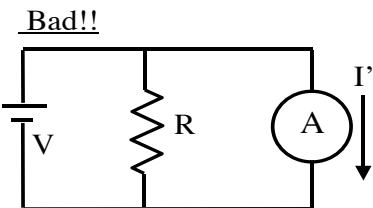

If you put the ammeter in parallel, like this, it's very bad. You'll blow a fuse, burn out your battery, make sparks... Why?

Remember, the ammeter has zero resistance - you have *short-circuited* the battery.

(The current is happy to flow through the ammeter, with $R=0$, so $V=I'R$, but if $R=0$, and V is finite, I' will be VERY big!)

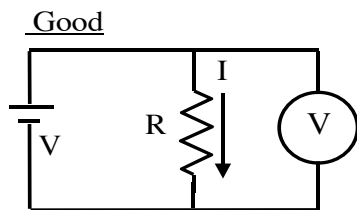

To measure the voltage "V" across the resistor, you must place the voltmeter in parallel, as shown. The voltmeter will read off "V" for you

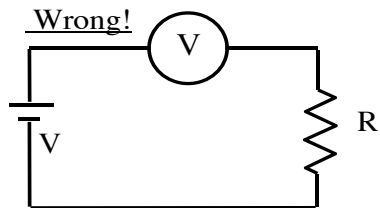

This circuit is badly designed. Remember, voltmeters have very LARGE internal resistance. In this circuit, no current can flow! ($V=IR_{\text{tot}}$, R_{tot} is huge, so $I = 0$).

There will be no current, (so no voltage "drop" across the external resistor) and the voltage drop across the meter will be the battery voltage. Nothing will "burn out" like in the previous bad example, but you won't get the reading you were really interested in.

Note: real batteries always have some small, unavoidable internal resistance "r" in them. We can usually neglect it, but in real life, if e.g. you short circuit a battery, the current is large but never infinite due to the small but finite "r".

A real battery can be "modeled" in the following way:

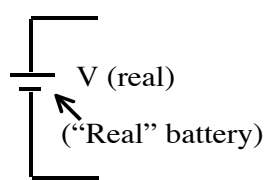

=

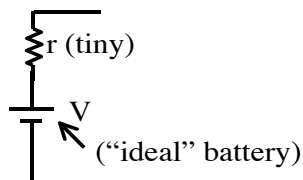

Giancoli writes an ideal voltage source as "EMF" (with a curly \mathcal{E}) instead of V.

If you ever need to think about circuits with real batteries instead of ideal ones, just add in a small "internal resistance" r next to the battery. As batteries get old, the internal resistance gets larger (and so they put out less current)

Have you ever noticed that if you start your car with the lights on, the lights dim? That's because of the internal resistance of the car battery- as current flows, there is some voltage drop across "r", which means less voltage for the light bulbs...

Finding R_{equiv} piece by piece, like we've done, usually works fine. But sometimes, circuits get a little too complicated. E.g.

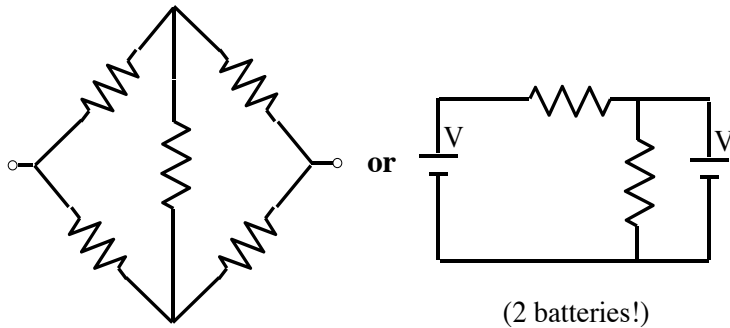

You can still find the currents and voltages throughout, using ideas we call "Kirchoff's rules". (There's nothing especially new here, we've already intuitively seen and used the rules!)

Kirchoff's first rule is a statement of the consequence of conservation of charge: "whatever current goes in, must come out".

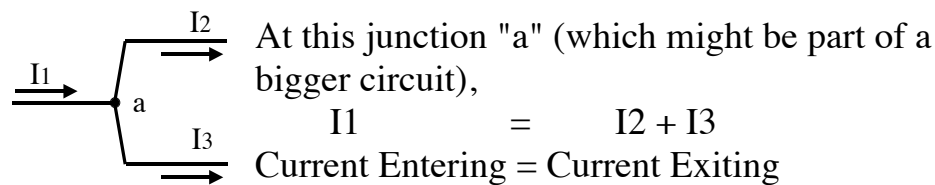

Just be careful to watch the arrows. You will be drawing arrows for currents, and they might point either way. E.g. in this picture:

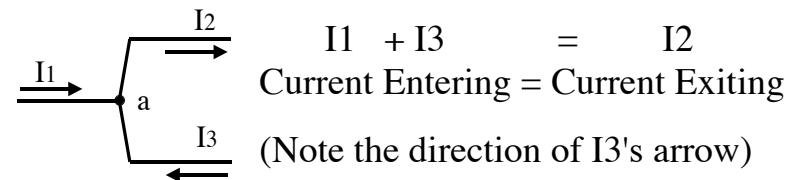

Example:

Look at the junction labeled "a". Here,

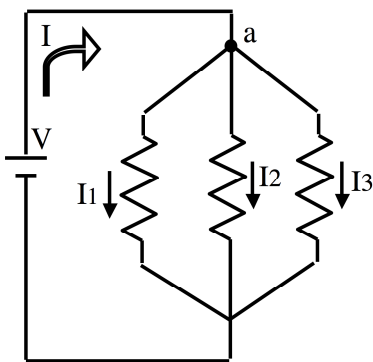

$$I = I_1 + I_2 + I_3$$

(I enters, the other three exit)

(Look back at p. 19-5, the discussion about household wiring. We had this same diagram.

I is the total current drawn by your house. I1, I2, and I3 are currents in the individual appliances.)

Kirchoff's second rule says "The sum of voltage changes around any closed loop is always zero". (This is just conservation of energy.) Think of our ski-lift analogy, where voltage \leftrightarrow height. As you move around the ski area, you go up and down, but if you make a loop (ending up right where you started), the total sum of all rises plus all drops will add to zero!

Example: Consider the following circuit (by now familiar!)

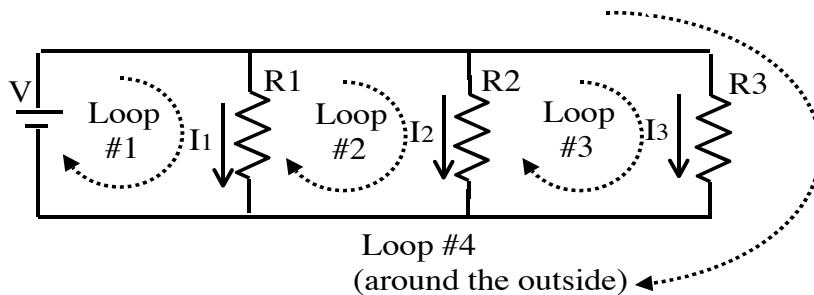

Look at the loop labeled #1. You can start wherever you want, let's begin at the bottom and imagine "walking around" the loop in the direction shown. We first go UP the battery (voltage change $+V$), and then we go DOWN the resistor R_1 , with voltage change $-I_1 R_1$. It's a drop - think hard about every minus sign here:

$+V - I_1 R_1 = 0$ (Or $V = I_1 R_1$, which if you think about it makes sense! Resistor R_1 has a voltage V across it, after all)

Alternatively, you could go around the loop labeled #4. (That's going around the whole circuit, basically). Now you go up the battery, across the top (no voltage drop there), and then down resistor R_3 . So Kirchoff's second rule says

$+V - I_3 R_3 = 0$ (Or $V = I_3 R_3$, again makes sense)

Another alternative: Loop #2. Thinking of this in the "skier analogy", loop #2 is for backcountry skiers. You ski UP R_1 , and then back down R_2 . Kirchoff's second rule would say

$+I_1 R_1 - I_2 R_2 = 0$ (Or $I_1 R_1 = I_2 R_2$, both also $=V$, again makes sense)

Notice the signs. The $I_1 R_1$ term is $+$, you're going UP the hill there (going against the current), so your voltage is increasing....

Kirchoff's rules are fairly intuitive, except the signs can be tricky! Unfortunately it's critical that you get them right. Currents always have arrows (directions) associated with them, and so do the loops.

 If you are going around a loop and encounter a resistor with a current like this, then IF you are heading RIGHT -->, you're travelling WITH the current, the voltage DROPS across R, so the change is $-IR$.

On the other hand, if you happen to be going around the loop the other way, <--, (so you're "fighting the current"), you're going UP the hill, change in voltage is $+IR$.

Batteries can also be confusing:

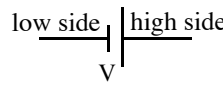
 If you are going around a loop and encounter a battery like in this picture, then IF you are heading RIGHT -->, you're travelling from the low V side to the high V side of the battery, the change is $+V$.

On the other hand, if you are going around the loop the other way, (<--), then you're going DOWN the hill (down the battery) and the change in voltage is $-V$. (Think of the ski lift analogy)

Example: Let's figure out the currents in each of the resistors here.

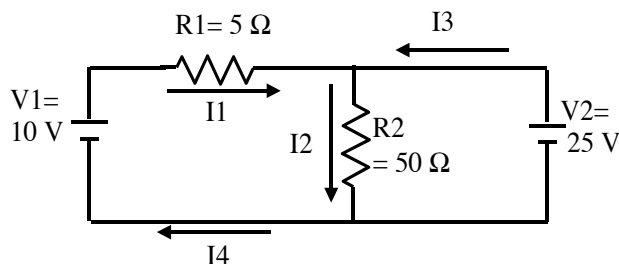

The first step is to draw arrows for currents, and label them.

The direction you initially pick for the arrow is arbitrary! It doesn't matter. If you solve for, say, I_1 in the picture above, and if it happens to come out negative, that just means the real current is heading the OPPOSITE way from the arrow you drew. (So, it'd be left, in the picture above.)

Before proceeding, try to avoid making up too many different symbols/labels for currents. E.g., in this example, look over on the left. I_4 is entering the battery (labeled V_1) and I_1 is leaving. But Kirchoff's rule #1 says "what goes in, must come out". That's true everywhere, including batteries. So $I_4 = I_1$. Why make up a different label? Just replace I_4 with I_1 ! There are then only 3 unknowns, rather than 4...

Here's the circuit again, with currents (and a few points) labeled.

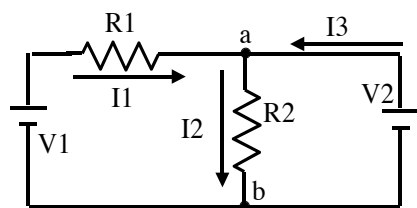

What we're after is I_1 , I_2 , and I_3 .

Look at junction "a", we have

$$I_1 + I_3 = I_2 \quad (\text{Eq'n 1})$$

(current in = current out: watch the arrows!)

That's ONE equation, for three unknowns! We need two more.

It turns out, in this case, that no more "current junctions" (i.e. Kirchoff's first rule) will help. We could TRY, look e.g. at point b.

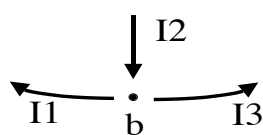

At point b, Kirchoff's first rule says

$$I_2 = I_1 + I_3.$$

(Current in = Current out)

But that's the same equation we had before!

So we use Kirchoff's *second* rule for our other two equations.

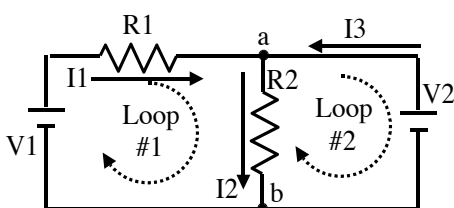

Here's the circuit one more time, with some loops labeled:

Let's follow Loop #1.

We can start wherever we want, e.g. at point b, and go around. Watch all the signs!

$$+V_1 - I_1 R_1 - I_2 R_2 = 0 \quad (\text{Eq'n 2})$$

We climbed UP the battery V_1 , it's +. We went DOWN both of the resistors R_1 and R_2 (i.e. we went WITH the current), so they're both voltage drops, or negative. Putting in numbers, we have

$$+10\text{ V} - I_1(5\Omega) - I_2(50\Omega) = 0 \quad (\text{Eq'n 2 with numbers})$$

We need one more equation. Just pick another loop (any one will do). E.g., let's go around loop #2, starting this time at point a.

$$-V_2 + I_2 R_2 = 0 \quad (\text{Eq'n 3})$$

As always, the minus signs are important to understand. Look at the picture again: this time, when we pass battery V2, we are going DOWN the battery (from the "high" side to the "low" side indicated by the long and short horizontal lines on the battery symbol, respectively.) That's a voltage DROP. It's like we took the ski lift labeled V2 DOWN the mountain! That's why V2 got a minus sign above.

Similarly, now we're climbing up the resistor R2. (We're fighting the current I2) That means we're going uphill: the voltage change is plus, so that's why we have +I2*R2.

Putting in numbers,

$$-25 \text{ V} + I_2 (50 \Omega) = 0, \text{ or (solving for } I_2),$$

$$I_2 = 25\text{V}/50 \text{ Ohm} = \mathbf{0.5 \text{ A}}$$

We can plug this value for I2 back into Eq'n (2), giving

$$10\text{V} - I_1 * 5 \text{ Ohm} - (0.5 \text{ A}) * 50 \text{ Ohm} = 0, \text{ or (solving for } I_1)$$

$$I_1 = [10 \text{ V} - 0.5\text{A} * (50 \text{ Ohm})] / (5 \text{ Ohm}) = \mathbf{-3 \text{ A}}.$$

Finally, Equation 1 said $I_1 + I_3 = I_2$, or $(-3\text{A}) + I_3 = 0.5 \text{ A}$, so $I_3 = \mathbf{3.5\text{A}}$.

I1 came out negative. So we guessed wrong: current I1 is really heading left. It's going INTO the left-hand battery. That's a little unusual, the big 25V battery on the right is pumping current INTO the 10 V battery on the left, it's being "charged". Only specially designed batteries can be effectively recharged, for most normal ones this won't work. (You might damage the battery on the left.)

What does "charging" mean? Well... batteries can only put out so much total charge = current*time, and then the chemicals inside die. So for the short term, recharging is irrelevant, (the circuit diagram tells you what happens, regardless of whether the battery is rechargeable or not) but after a long time, the voltage (and current) of a normal battery will become zero, unless you can recharge it!

RC Circuits: (I suspect we will not cover this - so stay tuned to decide if you need to read this. But even if we don't cover it, you might find it interesting!)

Putting capacitors into circuits is a bit of a funny business. E.g.,

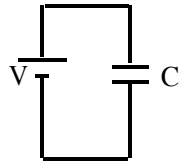

The battery on the left will charge up the capacitor on the right. Charges move onto the top plate, and off the bottom plate, until finally $Q=CV$ has built up on both plates. Then, no more charges will move.

So there's briefly a current (as charge flows from the battery to the capacitor), but then the current stops.

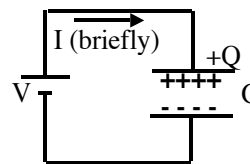

Now consider a circuit with no battery at all, just a capacitor and a resistor. Let's begin with the capacitor all charged up

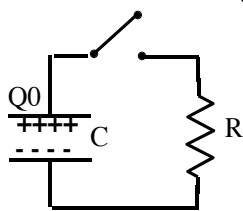

(like we just described), and the switch open, as shown here.

Let's suppose we start with charge Q_0 , and voltage V_0 , across the capacitor. ($V_0 = Q_0/C$, of course)

At time $t=0$, we close the switch. What happens? The capacitor is now able to discharge! At first, a large current, I , will flow. (There's a voltage across the resistor at this point, and $V=IR$) This situation is similar to a simple "battery and bulb" circuit (like way back on P. 19-1), but capacitors aren't batteries.

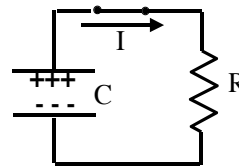

The capacitor runs down, quickly! Current doesn't CONTINUE to flow, like it does with a battery.

So the current STARTS off strong ($I_0 = V_0/R$), but it will decay away with time.

At any instant in time, we have the following relations:

$$V = IR$$

$$V = Q/C$$

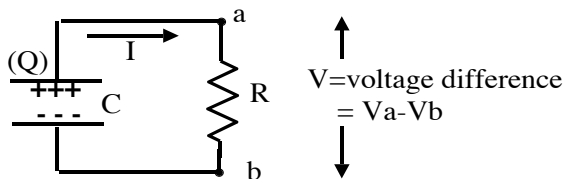

The voltage "V" is the SAME voltage across the capacitor and the resistor. (Look at the picture, $V=V_a-V_b$ in the picture, it's the difference in potential between top and bottom)

What is I? It's the charges flowing/second. Where do the charges come from? They were stored on the capacitor plate!

$$\text{So } I = -\Delta Q / \Delta t.$$

(If charges *leave* the capacitor, they must flow through the resistor. The minus sign says that Q is *decreasing* when current flows in the direction shown)

Putting this together with the equations above gives

$$\frac{\Delta Q}{\Delta t} = -I = -\frac{V}{R} = \frac{-Q}{CR}$$

In words, the RATE at which charges leave is proportional to the AMOUNT of charge still sitting on the plate. (Q on the right side is of course changing all the time, this equation holds at some instant)

Look at the units:

$$[RC] = [\text{Ohm} \cdot \text{Farad}] = [V/I][\text{Coul}/V] = [\text{Coul}/I] = [\text{Coul}/(\text{Coul}/\text{sec})] = \text{sec}$$

(This makes sense, $\Delta Q / \Delta t$ SHOULD be charge/time)

We define the quantity $\tau \equiv RC$. (That's the Greek letter "tau")

Whenever you have something decaying, and the rate is proportional to how much you have left, you get "*exponential decay*". The mathematical formula for Q as a function of time is

$$Q(t) = Q_0 e^{-t/(RC)} = Q_0 e^{-t/\tau}$$

There are MANY examples of "exponential decay" in nature. Some examples: cooling objects (where the temperature decays with time), or radiation (where the number of particles decays with time), or drug concentrations (where the amount decays with time)...

In the exponential decay formula, "e" is a number, $e=2.718\dots$ It's a little like Pi. It's also called the "base of natural logarithms".

$e^{\text{something}}$ really means $2.718^{\text{something}}$.

(You do NOT use the "E" or "EE" key on your calculator! Look for the e^x button)

Since $V=Q/C$, we have (dividing that last equation through by C)

$$V(t) = V_0 e^{-t/(RC)} = V_0 e^{-t/\tau}$$

At time $t=0$, you have $e^{(0)} = 1$, in other words $V(0) = V_0$. (Duh)

If you wait till a later time, the formula tells you what the voltage is (or, the earlier formula tells you the remaining charge on the plates)

Example: When $t=\tau$, (i.e. if you wait a time $t=RC$ seconds, which is also called waiting "one time constant"), then you have

$$V(\tau) = V_0 e^{-1} = \frac{1}{e} V_0 = \frac{1}{2.718} V_0 \approx .37 V_0.$$

The voltage has dropped to almost a third of where it started.

If you wait TWO time constants, i.e. $t=2RC = 2*\tau$, then

$$V(2\tau) = V_0 e^{-2} = \frac{1}{e^2} V_0 \approx .14 V_0$$

Here's a sketch of Voltage as a function of time:

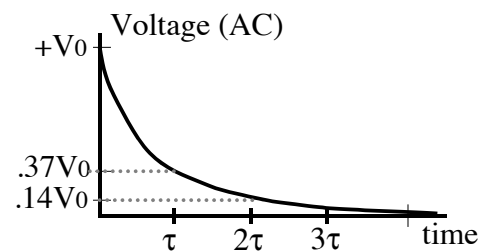

Whenever you wait "tau" more seconds, the voltage (or similarly, the charge) has decreased to $1/e = 37\%$ less than what you just had.

Example: Consider the following "RC" circuit:

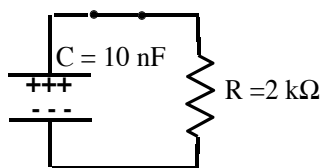

$$\text{Here, "tau"} = RC = (10 \cdot 10^{-9} \text{ F}) \cdot (2000 \text{ Ohm}) \\ = 2 \cdot 10^{-5} \text{ sec.}$$

The time constant of this circuit is $2 \cdot 10^{-5}$ sec. (pretty short)

Suppose you begin with $Q_0 = 50$ microC of charge.

(So $V_0 = Q_0/C = 50 \cdot 10^{-6} \text{ C} / 10 \cdot 10^{-9} \text{ F} = 5000 \text{ V} = 5 \text{ kV}$)

The charge will begin to leak off (through R).

After $2 \cdot 10^{-5}$ sec (one time constant), you will have

$$Q(\tau) = Q_0 e^{-1} = \frac{1}{e} Q_0 \approx .37 Q_0 \approx 18.5 \mu\text{C} \text{ left on the plates.}$$

After $4 \cdot 10^{-5}$ sec (two time constants), you will have

$$Q_0/e^2 = 6.8 \text{ micro Coulombs left.}$$

You can plug ANY time into this formula. E.g., after one second, you have $Q(1 \text{ sec}) = Q_0 e^{-(1 \text{ sec})/RC} = Q_0 e^{-1/(2 \cdot 10^{-5})} = 50 \mu\text{C} e^{-5 \cdot 10^4} \approx 0$

It's long gone!

TV and computer monitors usually have BIG capacitors in them to store up charges. They also have big resistors across those capacitors, and often have very high voltage power supplies (converting the 120V at the wall to much higher voltages, many kV, inside). So $Q_0 = CV_0$ is large (lots of charge stored!) and $\tau = RC$ is also large (the time constant is big, it takes a relatively long time for that charge to leak back off the capacitors). If you open up a monitor and start poking around in there, you're liable to get into big trouble.

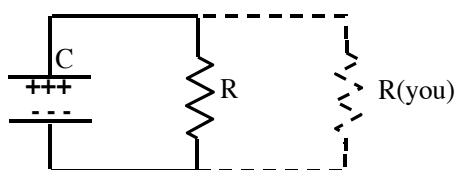

You provide a LOWER resistance path for the charges to flow through - the current goes through YOU (with a smaller time constant, i.e. quicker!)

The inside of TV's and computer monitors can be pretty dangerous, *even when they're unplugged*, because the capacitors in them can hold a lot of charge for a long time (even after being disconnected to the external voltage source.)