

**Magnetism:** In 2010 & 2020 so far we've seen 2 fundamental forces of nature: gravity and electrical forces. Electrical force depends on the existence of charge – charges *make* E fields, and then E fields in turn exert forces on other charges,  $F = qE$ . There is another kind of force in the world, called **magnetism** (attracting “rocks” were found in Magnesia > 2,000 years ago). You've surely played with kitchen magnets. They stick to some materials but not others. E.g. magnets don't stick to aluminum. *Magnetism is not equal to Electricity! They are different forces!*

E.g.: Hold a magnet near the electroscope (which is very sensitive to even tiny amounts of electric charge). Nothing happens!

E.g.: Hold a magnet near those electric dipole seeds we used to demo E-fields. You'll see nothing.

E.g.: Charge up a balloon, hold a magnet near it. Nothing!!

Magnetic forces are new, a different force than electrostatics.

**Phenomenology of Magnets:**

Play with magnets a little! Some attract, and some repel.



In fact, all magnets seem to have 2 “sides” or “poles”.

Once you've labeled the poles, you'll notice they act like this:

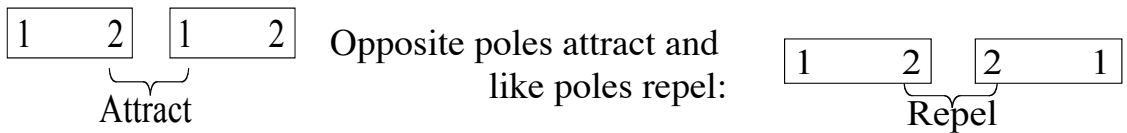

This is a bit like electricity, where we also had two charges: opposites attracted while likes repelled. But this is not electrical!

So let's avoid naming the magnetic “charges” + and -.

Here's another name: “N” and “S” (North and South). We'll label one (arbitrarily) and then we can figure out all the others in the world.

Unlike electricity, you'll never see: N (impossible) N

You always have N S called a "**dipole**" magnet, because it has two (different) poles.

If you break a magnet, you DON'T get one "N-only" and one "S-only" magnets, instead you simply get two smaller dipole magnets!



There is a *magnetic field* which (like E-fields) extends through space. It exerts a force on other magnetic objects. (It's a vector associated with every point in space)

We can use little “test magnets” to map out a B field (just like little “test charges” mapped E-fields for us.)

E.g. Iron filings, or a small compass, near a magnet.

The compass can define the direction of those lines. We can draw arrows on field lines (pointing where the compass does). (Looks rather like an electric dipole E-field pattern!)

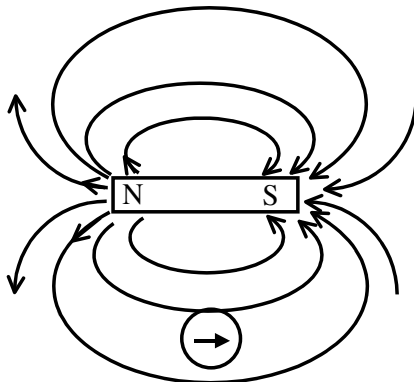
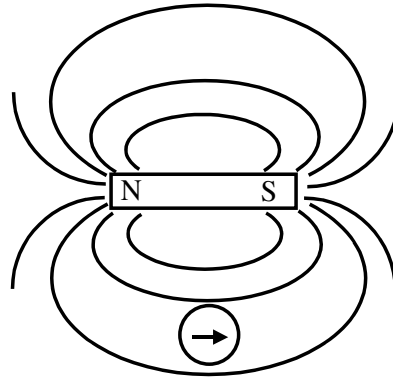

Remember, opposites attract, and a compass needle's tip is (*by definition*) “N”, so the compass points towards (is attracted to) the “S” pole of other magnets.

The Earth is a giant magnet:  
A compass points towards the geographic “North” of the planet, so the magnetic “S” pole (of the giant hidden magnet) sits up near the planet's geographic N pole!  
(It's a little strange, think about this picture until you understand the conventions)

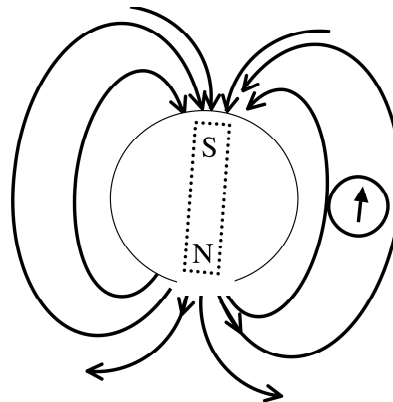

Some key questions to ask now:

- What makes/causes magnetic fields (call them B-fields)?
- Can we quantify the strength of B-fields?
- Can we quantify the effects of B-fields?

Lots of experiments were done (1800's) to figure this out. E.g.:

- 1) (Oersted discovered) B-fields are always created by currents, i.e. by moving electrical charges! (So although B-fields and E-fields are very different, they are also related too)
- 2) B-fields always *exert forces* on any other currents.

So what about regular magnets? (Where's the *current* in a kitchen magnet? You don't need to buy batteries for them, right?!)

Answer: All atoms have tiny currents around them, all of the time! (Just the electrons in orbit.)

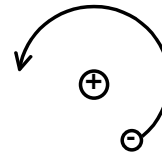

But normally, atoms are randomly oriented, so there's no net effect. (Magnetic fields of *different atoms* cancel)

But if the atomic currents all line up (which happens only in unusual and special materials, like ferromagnets!) then they act magnetic.

This happens in E.g. iron (Fe), Nickel, Cr, not too much else.

The “rules” of magnetism we’re about to discuss cannot be derived, they are experimental facts. They look crazy, in fact, but this is how the world apparently works!

**Rule #1: Given a current, what is the B field?**

Currents (I) always spontaneously form B-fields around themselves. (Compare with the old rule “charges make E-fields around themselves”) We'll discuss the formula for the *strength* of B in a few pages.

But for now, let's just look at the *pattern*:

The B field lines form **CIRCLES** around the wire (or current)

The *direction* of the B-field is found with the

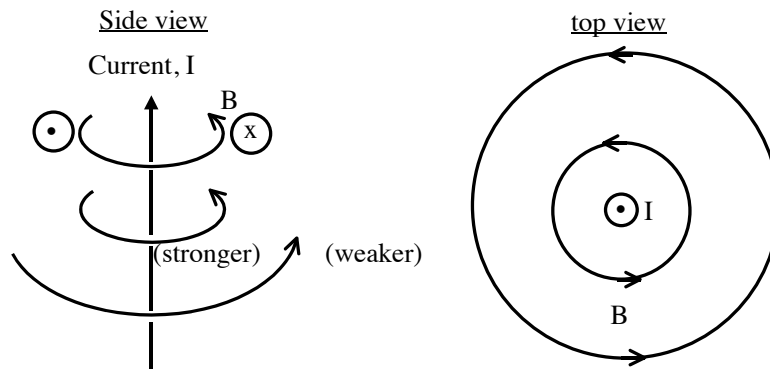

**Right Hand Rule #1. (RHR1):**  
 Take your right thumb, point it along the current direction, I .  
 Your fingers naturally curl around the current the same direction **B** does.

(Try it, see if you understand the directions in the pictures above)

Note: the pictures are meant to be 3-D. I use a standard convention:

⊙ means the field is pointing **AT** you (out of the paper)

⊗ means the field is pointing **AWAY** from you (into the paper).

To remember this, I sometimes think of the X as saying “dig here, buried treasure.”

Other people think of an arrow. 

If it points towards you, you only see the tip. ⊙

If it's running away from you, you see the tail feathers... ⊗

Example: A current flows around a ring (a loop). What does the B field look like?

*Answer:* We can't yet exactly *derive* the answer, but you can see it intuitively just from the previous rule. Think about the B field produced by little *pieces* of the wire, and then imagine “superposing” them, building up the total B field. Here’s my sketch - think about it a little, does it make any sense to you?

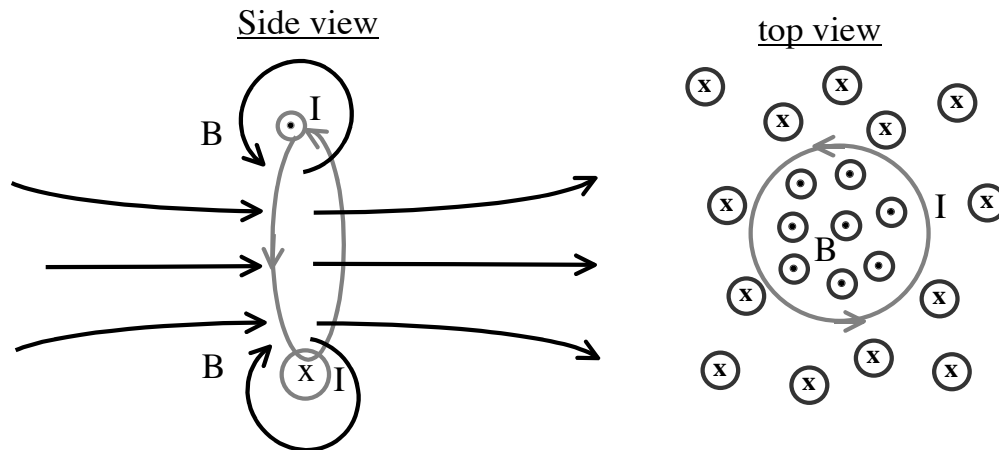

Look again at this figure. Some people introduce another “Right Hand Rule” for this situation, which we might call “**Right Hand Rule #1b**”

**RHR1b:** To find the B field near a current *loop*, rather than a long wire: If your right hand fingers curl with the current in a current loop, your thumb points in the direction of the B through the center of the loop.

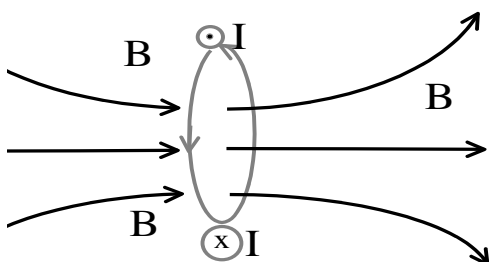

This is different than the RHR#1 (where your thumb pointed with I, and your fingers pointed like B! )

So don't mix them up! You never absolutely need RHR #1b, but I just find it much quicker and easier when

you have current loops to deal with. (Which we will, often.)

**Rule #2: Given a B field, what force does a current feel?**

B-fields exert a force on currents. If you put a current I into some external B-field, the current is *pushed sideways*.

The size of the force has been measured in many exp'ts, and the following formula summarizes the data:

**Magnitude of force:**  $F = I L B \sin\theta$

Here, **I** = current (in Amps)

**B** = strength of B-field

**L** = length of the wire in B-field

**θ** = Angle between I and B

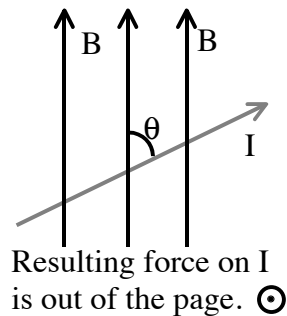

**Direction of this force: Right Hand Rule #2 (RHR2)**

- Point your right-hand fingers in the direction of I.
- Orient so your fingertips can curl naturally towards B.
- Stick out your thumb. It points in the direction of **F**.

In the picture above, the force on the wire points out of the page:

The wire in the picture will get pushed towards you, out of the page.

Convince Yourself!! The RHR's take some practice.

(Note: **F** is always perpendicular to **B**, and to **I**) You must think in 3-D.

We have *not derived* any of these results, it's simply what exp'ts tell us...

If  $\theta = 90$ , F is max:  $F_{\max} = ILB$  (into page, here):

Convince Yourself!

So  $B = F_{\max} / IL$

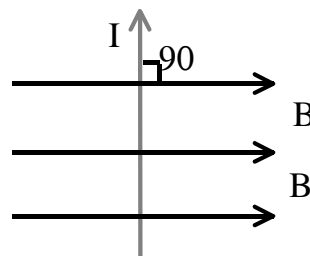

Resulting Force direction (into the page) ⊗

This in fact defines the numerical value of B!

Units [B] = N/(A\*m) = 1 Tesla = T

1 Tesla is a lot. The Earth's natural field is B about  $0.5 * 10^{-4}$  T.

- An old unit for B is "Gauss," 1 Gauss =  $10^{-4}$  T. That means

$B_{\text{earth}} = 0.5$  Gauss, roughly.

- Kitchen magnets are around 50G or  $5 * 10^{-3}$  T = 5 mT.
- Industrial magnets = 1 or 2 T (that's a natural limit for Iron)

(This is a typical NMR field. It's a strong magnetic field)

- Superconducting magnets might reach 10 T (I think 14.7 T is the current world record?) <http://enews.lbl.gov/Science-Articles/Archive/14-tesla-magnet.html>

Example: Take a “horseshoe magnet” (Which generates a big B-field between its poles, but nowhere else. ) Remember B points from N towards S. Run a small current, I, into the page through this big B field.

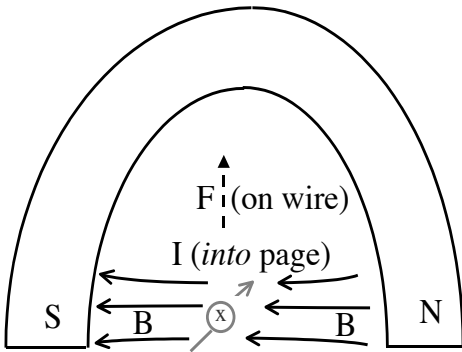

RHR#2 says F on the wire is up (convince yourself!)  
 This wire gets "sucked up" towards the horseshoe magnet.

The magnitude of the force is  $F = I L B$  (L is the the length of the wire that is in the B-field)

NOTE: the B field here is "external", created by the horseshoe magnet. The wire itself will also create its *own* little B field (looping around it), but we're not concerned about that here.

Example: Take that horseshoe magnet and reorient it so “N” is in front of the page, “S” is behind. As shown, B now points into the page.

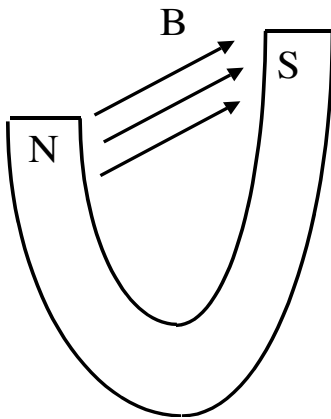

Now lower a current carrying square *loop* of wire into this B-field. . (The B-field is localized in the region between the two poles. It's zero pretty much everywhere else in space.)

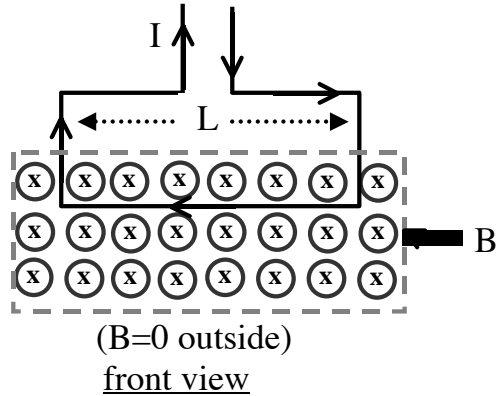

There will only be forces on the parts of the wire that are in the B-field.

Use the 2nd RHR, and convince yourself which way the forces are on the various "segments" of the current loop. I've drawn them here:

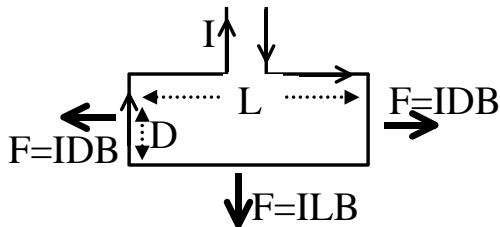

The forces on the left & right cancel, but because of the lower segment, there remains a net force, down.

As shown, the current loop is “sucked in” to this particular B-field. If the current I ran the other way, it would be "shoved out", can you see why?

The force on the loop in that last example is very real - it could be measured with a scale - a way to deduce the strength of the B field with a perfectly ordinary mechanical scale. E.g.,

if  $I=20$  A, (Typical large current in household wires)  
 $L=10$  cm, (Typical large horseshoe magnet width)  
 $B=1$  T (A very strong magnet!)

then  $F=I L B=(20 \text{ A})(0.1 \text{ m})(1 \text{ N/Am}) = 2 \text{ N}$ .

Not huge, but you could easily feel this, and accurately measure it.

This force has nothing to do with the metal or material of the wire itself. It is really the moving charges themselves, the *current*, that feel(s) this force. If you turn off the current, this force will disappear.

E.g. A beam of protons flying through B would also feel the magnetic force, even though there's no wire anywhere at all.

$F= I L B \sin\theta$  ← Our formula for a wire, or current.

$F=q v B \sin\theta$  ← The new formula for individual particles.

Where  $v$ =velocity of the particle,  $q$  is the charge.

[These are really one and the same formula!

Why? If you're interested, consider this:

$$I = \text{\#charges/sec} = Nq/t$$

$$v = \text{dist/time} = L/t$$

$$\text{So } I L B = (Nq/t)(L)(B) = Nq \cdot vB$$

That means all  $N$  charges feel a total force of  $NqVB$ , so each charge feels  $qVB$ . ]

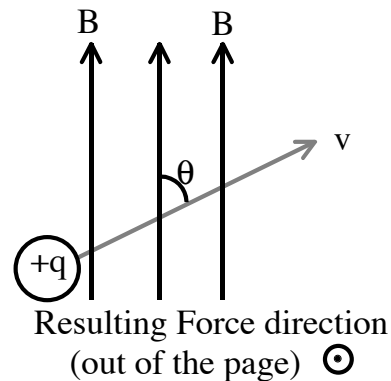

The direction is just as before: Use the exact same RHR#2.

**Except** be careful if the  $q$ 's are negative, then the direction of  $F$  must be reversed!



Example: Two charged particles enter a region of uniform B which points into the page, as shown.

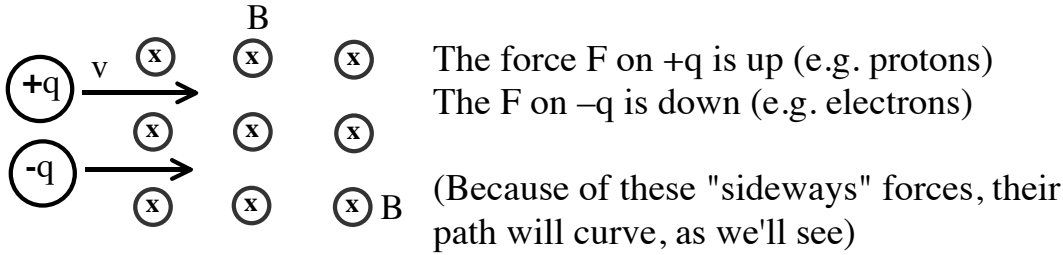

These formulas are Bizarre! This is all bizarre! Look:

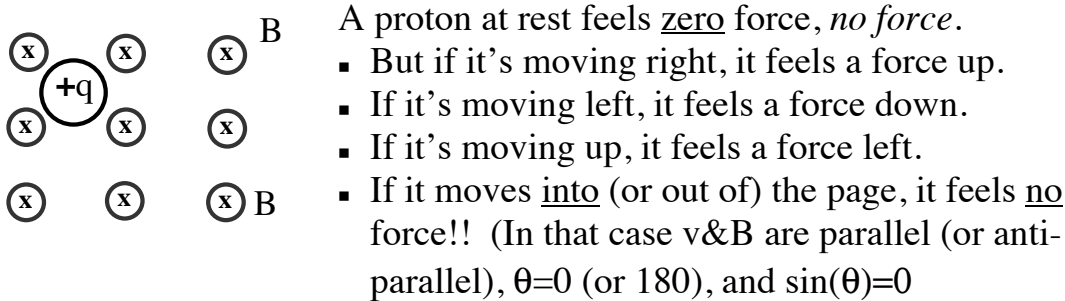

Bizarre but completely true. Nature has come up with a curious force!

Example: Uniform B pointing out of page:

Proton, initially moving with  $v_i$  to the right.

So F is initially straight down.

$v$  right, F down means it will curve down.

New velocity  $v'$  is "down-and-right."

New  $F'$  is shown.

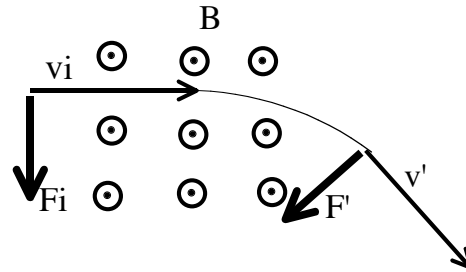

Note: F is always perpendicular to  $v$ . (By RHR#2)

So the work done by the B field =  $F d \cos\theta = 0$ .

This force does not speed up the proton, it is a centripetal force!

We've seen this before, Ch. 5, it's *uniform circular motion*.

F is  $qvB$ (constant), and acceleration is  $v^2/R$ : Newton II gives

$$qvB = (mv^2)/R \text{ or } \boxed{R = (mv)/qB}$$

The proton moves in a *circle* of radius R. Bigger B => tighter circle

There was nothing "special" about the proton in this problem - any charged particle in a uniform magnetic field will travel in circles.

(An electron, however, will curve the opposite *direction* because of its negative charge). This effect allows particle physicists to identify many properties of charged particles, even tiny ones, in "bubble chamber" pictures.

Now we know *force* on moving charges caused by B fields. (RHR #2)

We also know the pattern of B created by currents. (RHR#1)

But, what's the formula for B created by a current, I?

Discovered by Ampere. The math is pretty tough, though ("vector calculus".) The result for a long straight wire is simple enough:

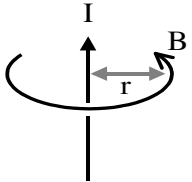

$$|B| = \frac{\mu_0 I}{2\pi r}$$

where  $\mu_0 = 4\pi \cdot 10^{-7}$  (Tm/A) is a constant of nature, and r is the distance you are away from the long wire.

The B field is proportional to I, but decreases with distance.

Consequence: What if you stick a second wire into the B field of the first wire? There will be a *force* on the second wire (it's a current in a B field, after all.) Let's figure out the magnitude and direction:

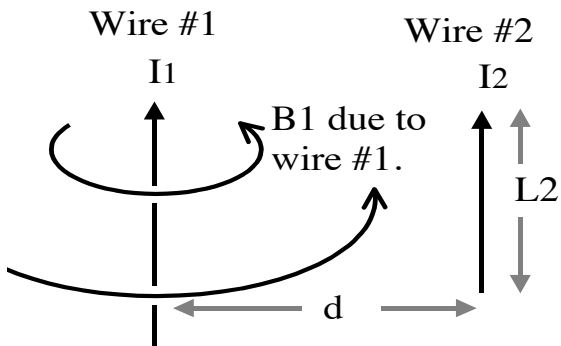

We know the force on wire 2 due to any B field is

$$|F| = I_2 L_2 B$$

We also know how big B is over there (where wire #2 is) from our formula above:

$$|B| = \frac{\mu_0 I_1}{2\pi d}$$

Plug this in, to get

$$\begin{aligned} F \text{ (on wire 2, of length } L_2) &= I_2 L_2 \frac{\mu_0 I_1}{2\pi d} \\ &= \frac{\mu_0}{2\pi} \frac{I_1 \cdot I_2}{d} L_2 \end{aligned}$$

The force *per unit length* on wire 2 is just  $\mu_0 I_1 I_2 / (2\pi d)$ .

What is the direction of the force?

RHR#2 says it is left (convince yourself!)

By symmetry, wire #1 is also attracted to wire #2.

That means these **parallel currents attract!**

(This is magnetic attraction, *not* electric)

Remember, "like charges" *repel*. But here, when magnetism is involved, "like currents" *attract!*

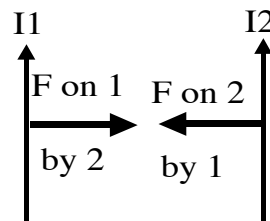

What if the currents go opposite directions?

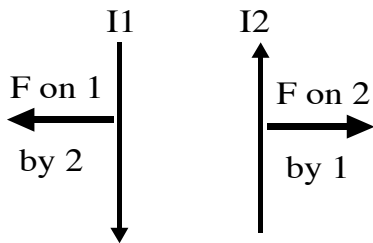

If you flip I1, this reverses the direction of B1 ( i.e. the B field due to current #1, over there at the place where wire 2 is), which in turn flips the direction of the force on 2 by 1.

*Convince yourself of both those statements.*

It's good practice of both RHR's.

That means **opposite currents repel.**

Note: The formula itself,  $F/\text{unit length} = [\mu_0 I_1 I_2 / (2\pi d)].$

is totally symmetric, if you replace "1" with "2", so

$F(\text{ on 1 by 2}) = F(\text{ on 2 by 1})$

(Newton III is always true, even for bizarre forces like magnetism!)

Example: Wires in your house are always really two wires like this (to

make a circuit, current goes in, it must also go back out again!)

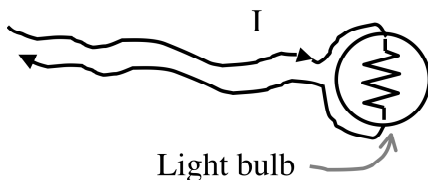

We just found the formula for the (sideways) force on the wires themselves:

$$F = [\mu_0 I_1 I_2 / (2\pi d)](L)$$

If you have a 2 m long wire to a lamp ( $L=2$  m), and the wires are wrapped together in a single cable, as they generally are, let's say 1 mm apart ( $r = .001$  m),. with a typical current of  $I = 1$  Amp (e.g. that's what you have for a single 120W bulb) then

$$F = [(4\pi * 10^{-7}) / (2\pi)] \{Tm/A\} [(1A)^2 / (10^{-3}m)] (2m) \\ = 4 * 10^{-4} Tm/A = 4 * 10^{-4} N$$

It's a small, barely noticeable (repulsive) force.

A big nuclear physics spectrometer electromagnet might have  $I \sim 50A$ ,  $r \sim 10^{-4}m$ , length  $\sim 1$  km of wire,

$$F = [(4\pi * 10^{-7}) / (2\pi)] [(50A)^2 / (10^{-4}m)] (10^3) = 5000N$$

= 1/2 ton of repulsive force! You have to build those things strong, or the magnetic forces between wires will blow up your device!

Imagine wrapping many wire loops next to each other:

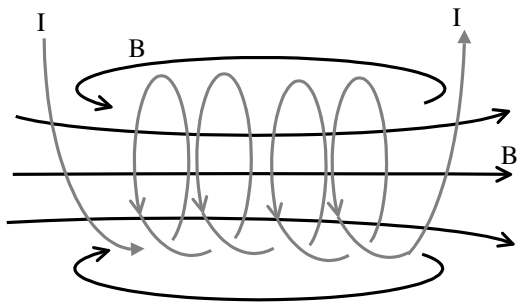

Each loop makes a  $B$  like the one on p. 20-6, and these *superpose*.

You get a strong and very *uniform*  $B$  field inside the loops. (It's very weak outside.)

We call this wire shape a **solenoid**.

From the *outside*, it looks rather a lot like an ordinary bar magnet!

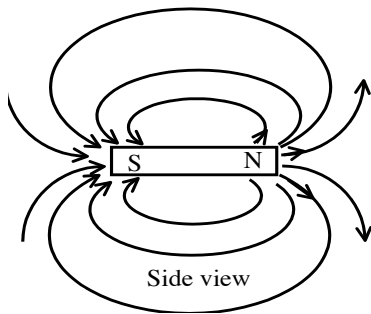

Indeed, that's basically what a bar magnet is like, microscopically, The wire loops, however, are not connected like in the solenoid- they are little circular atomic currents!

In this "head on" picture of a magnet (like eg the one above) the "I"s everywhere in the middle all *cancel* each other out.



Head on view:

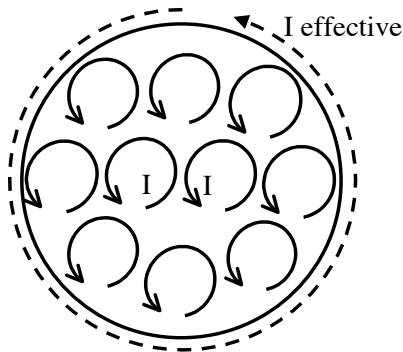

But at the *outside* edges, the "I"s add up to look a lot like a single, big ring of circulating current. (Thus, like the outside edge of a solenoid.)

In **ferromagnetic materials**, the atomic currents tend to line up like this, causing a large magnetic field to be created *naturally*.

This explains why bar magnets attract N to S (as we saw at the start of this section).

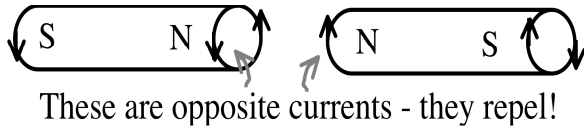
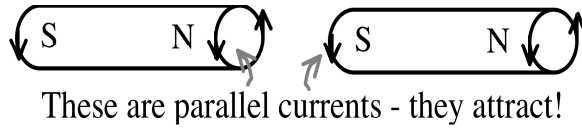

Iron naturally has small spatial regions (**domains**) that each act like small magnets, like on the previous page. They tend to be randomly oriented. So iron is *not* normally a magnet. (E.g, a normal nail doesn't stick to the fridge). But if you put iron into a strong external B field, this will tend to line up all those little domains, and you can **magnetize** iron this way. (See Giancoli for some sketches)

If you put iron inside a solenoid, the B field from the solenoid lines up the iron magnetic domains, which means the iron becomes itself highly magnetized, *adding* to the solenoid field. Result: a very powerful magnet. This is an **electromagnet**. Turning on the solenoid current lines up the domains => big B field. Turning off the solenoid current => the domains re-randomize, and the magnet gets much weaker.

But, *why* do the domains line up with the external B?  
Or, why do magnets "like" to line up with each other?  
(Answer on next page...)

Consider a current loop (or a "domain") inside an external B field.

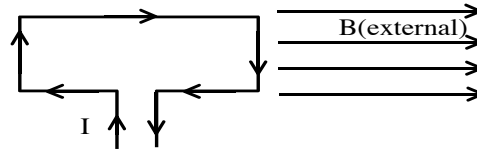

$F$  on the top wire is 0 (because  $\theta = 0$ ).

$F$  on the left wire is INTO the page.

$F$  on the right wire is OUT of the page.

Result:  $F_{net} = 0$ , but there is a *torque*, a *twist* on the loop...

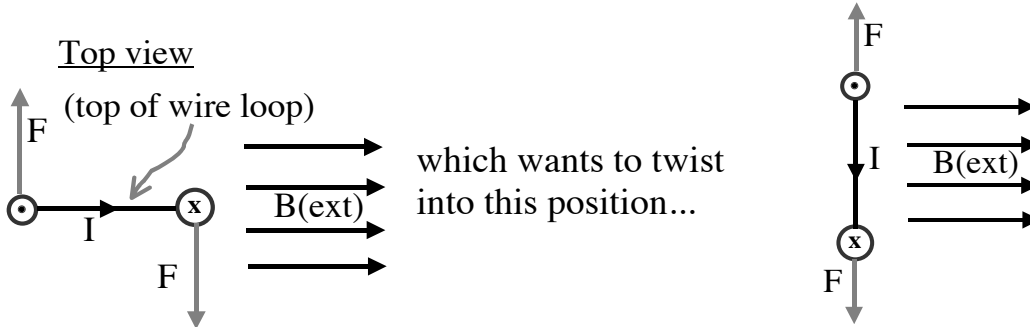

Note what happened: that loop had its *own* little B field (I didn't draw it, because it would clutter the diagram, but it points into the page in the figure at the top) originally. After it twists, that internal B field (which I still haven't drawn, but you can figure it out-) now points the *same direction* as the big B external!

Convince yourself of all this, using RHR #1 and #2.

Here, the current loop is basically a little magnet (*all* current loops are basically little magnets!) and we just worked out that it wants to twist to line up its own B field with the external one.

It's just what I claimed, magnets prefer to line up with their B fields parallel.

In an external B, the little atomic current loops themselves are twisted until the natural (internal) B points in the same direction as B external. It's not much different from the example above with a wire current loop.

A **galvanometer** is just the previous example in practical action:

You run a current "I" through a wire loop, (which is perpendicular to the page, see previous figures) and a coil spring resists the resulting twisting. More "I" means more torque, the needle moves farther.

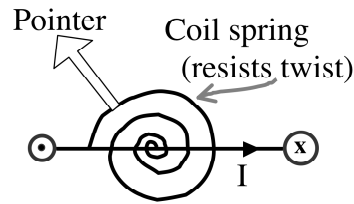

You can measure "I" this way, if B is fixed and known.

Or, if you know "I", you can measure "B" this way. It's a "B-meter".

**D.C. motors** work on this principle too. Imagine a loop in a B (external)

Top view

(top of wire loop)

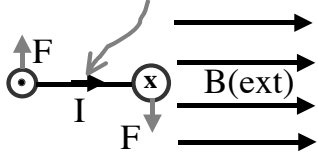

As shown, the loop starts to twist.

Suppose, when the loop just reaches its "equilibrium" position, (the orientation where it feels no more net twist, or torque...)

"Equilibrium"

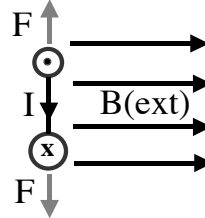

you then *turn off* "I".

The loop *had* been turning, and now it suddenly feels no forces.

It'll just coast. When it has coasted back to the original orientation again you could now turn "I" back on. It'll twist *again*. If you keep repeating this, it goes around and around. You have used a current, I, to give you physical motion. This is a simple motor! You could turn a drill bit, or car wheels,... (This simple invention has completely changed the world we live in. Think about everything done by electric motors!)

The practical trick is turning "I" on and off at just the right times.

(Or, better yet, *reversing* the direction of "I", so that instead of coasting it continues to twist itself the same way all the time) Real motors use **commutators** or **brushes** to turn the current on and off as the motor rotates. See Giancoli for better pictures than I can draw.

**Crossed E and B fields:**

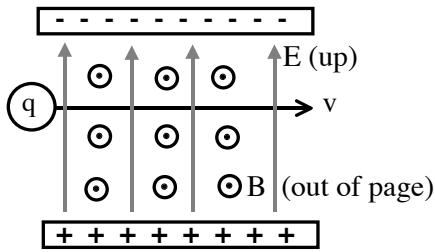

Imagine having both **E** and **B** fields together in one place. E.g, picture a capacitor (with a big **E** field) inside a magnet whose **B** field was perpendicular to **E**.

What would happen if you ran a charge "+q" through this region?

In this picture, we have an UPWARD electric force  $F(E) = qE$ .

We have a DOWNWARD magnetic force  $F(B) = q v B$ . (from RHR #2)

If  $F(E) \neq F(B)$ , the particle will curve, eventually hitting the plate.

But If  $F(E) = F(B)$ , the particle goes straight, because  $F_{net} = 0$ .

So if  $qE = qvB$ , or in other words if  $v = E/B$ , it goes straight.

If you send in a bunch of particles of different charges, different v's, different masses.... only those with the particular velocity  $v = E/B$  make it through out the far side. This device is a **velocity selector**.

*Note:* It doesn't matter what q is, not even what *sign*! It doesn't matter what "m" is either.

What can you do with a velocity selector?

Here's one example. Take that beam (so now you know v. By tuning E or B, you can *pick* the v you want!) and run it into a region of uniform **B**.

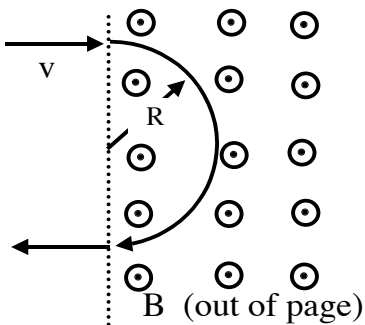

Remember, particles in uniform **B** fields follow a simple circular path.

They go in a circle with radius  $R = mv / (q B)$ .

Where the beam comes out at the bottom tells you the radius R. You can pick B. We already chose v. So this device will "read off" m/q.

A **mass spectrometer** is basically just like the above device.

It's fantastically useful to identify what "stuff" you have in your beam.

(m/q is pretty much unique for every different type of atom or particle).

This device is used by chemists, physicists, biologists, forensicists...

Think of how useful it is to identify even *single atoms* of some material!



Some final comments on this chapter:

1) If you *run* past static charges, you see (in your reference frame) a current running towards you. That means you see a **B** field. However, a stationary observer nearby sees only static charges. They see no **B** field! Who is right? Is there a **B** field there or not? Einstein thought a lot about this puzzle... (more on this later! Think about it yourself for now.)

2) **E** and **B** are clearly different. But they are also clearly related. Charges make, and feel, **E**. Currents make, and feel **B**. But current are just moving charges! **James Clerk Maxwell** in the late 1800's discovered/explained that there is really only *one* fundamental force at work here - **electromagnetism** - and one field, the **electromagnetic field**. The math involved is a little hairy for Phys 2020, but Maxwell's work is a beautiful **unification** of the two forces of electricity and magnetism. It's one of the grand and glorious achievements in physics, nearly unrivalled in mathematical beauty and practical significance.

3) All of classical mechanics is based primarily on Newton's laws. (3 of them, plus his law of gravity)

All of electromagnetism is based primarily on Maxwell's equations. (4 of them)

Together, mechanics and electromagnetism describe a *vast* amount of phenomena - the "classical" world we live in! Relativity and quantum mechanics finish off the story as we know it today, but at its heart, all the complexity and diversity of the physical world boils down to this tiny handful of simple laws of nature!

4) Parting thought for this chapter: we've learned that **E** fields can cause currents, which make **B** fields. Can you go the other way? Can a **B** field somehow make currents flow, or **E** fields (or voltage differences)? This was a *hot* question in the 1800's, and the answer (the subject of Ch. 21) once again changed the world we live in radically, because it's the basis for electric power generation!